

DEHNSCHRAUBEN FÜR DIE KIEFERORTHOPÄDIE
EXPANSION SCREWS FOR ORTHODONTIC USE

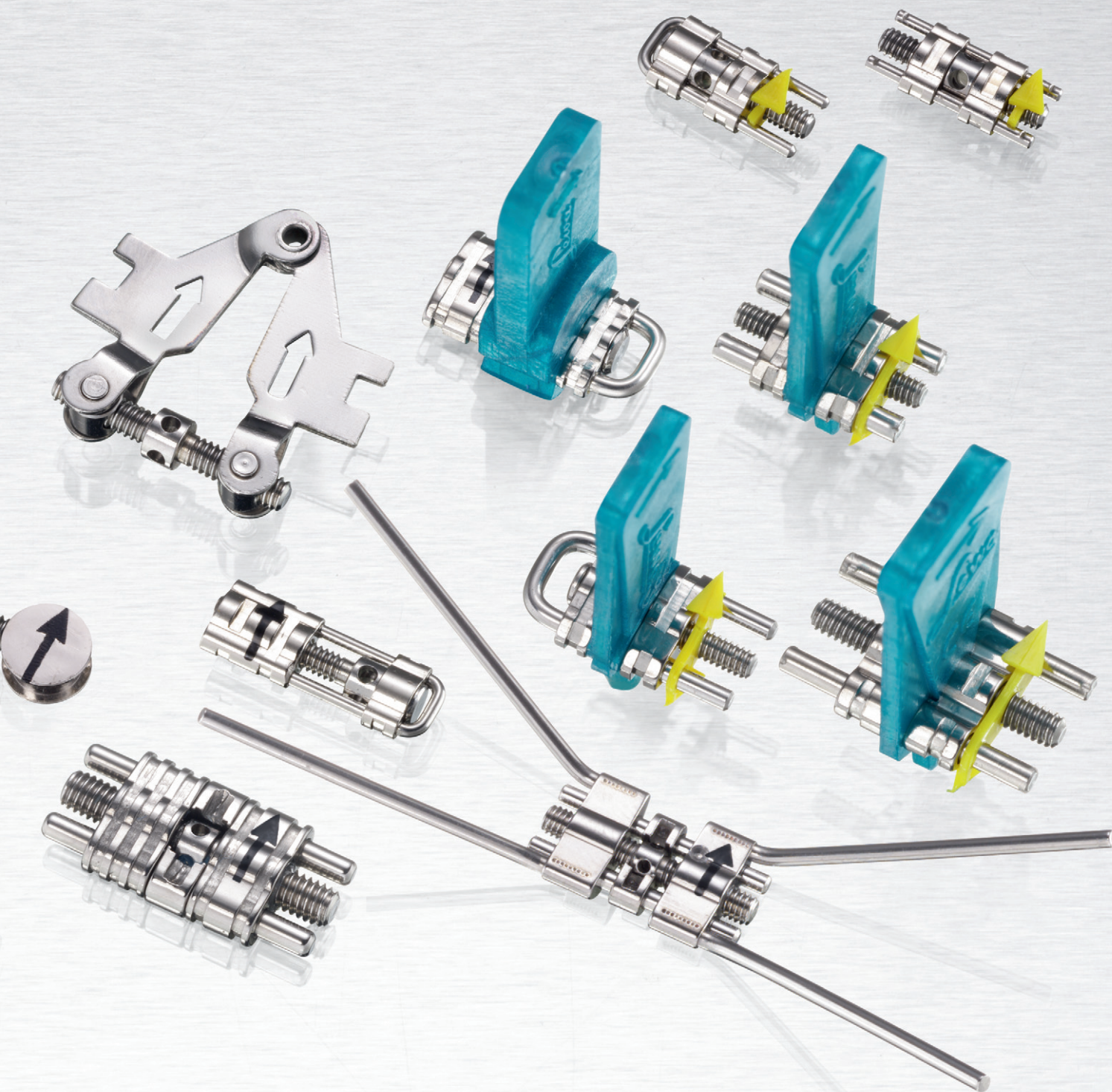

CE Micro-Serie Series

Doppelt geführte Dehnschrauben für allgemeinen Einsatz.

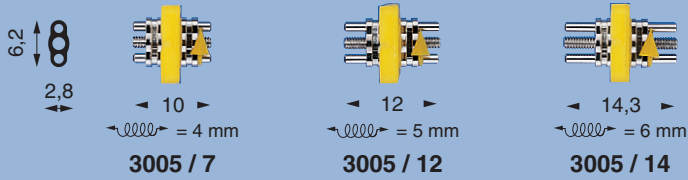

Medium-Serie Series

Double-guidance expansion screws for multiple use.

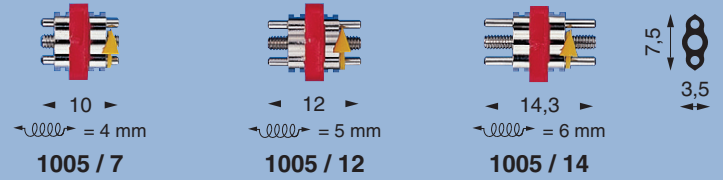

CE Skelettierte Sektorenschrauben zum Einsatz als Distal-Schraube oder für Einzelzahnbewegung. Stabile U-Bügel-Retention gerade oder abgewinkelt.

Skeleton-type sector screws for use as distal screws and for single-tooth movements. Stable U-bow retention, straight or bent.

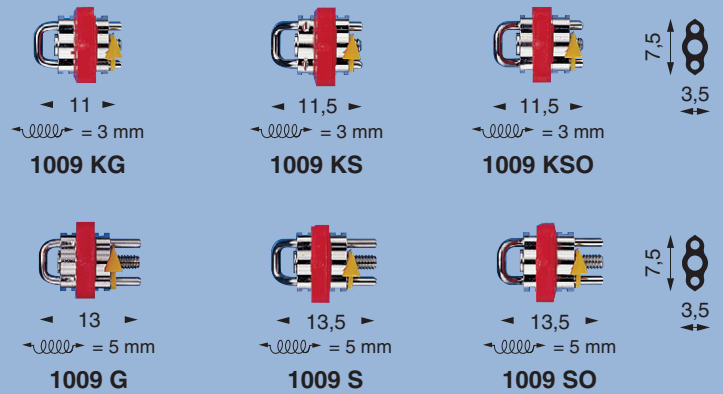
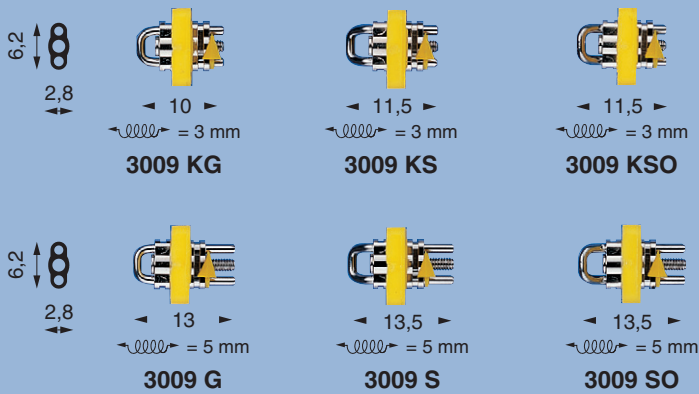

CE Nano-Serie Series

Dehnschraube
Expansion screw

Sektorenschraube
Sectional screw

Zugschraube
Traction screw

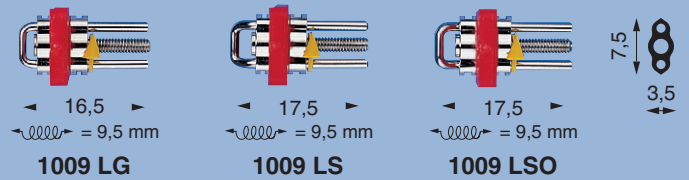
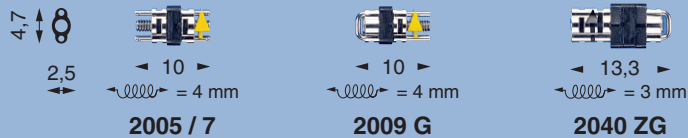

CE Zugschrauben zum Schließen von Zahnlücken. Stabile U-Bügel-Retention, gerade oder abgewinkelt.

Traction screws for closing gaps. Stable U-Bow retention straight or bent.

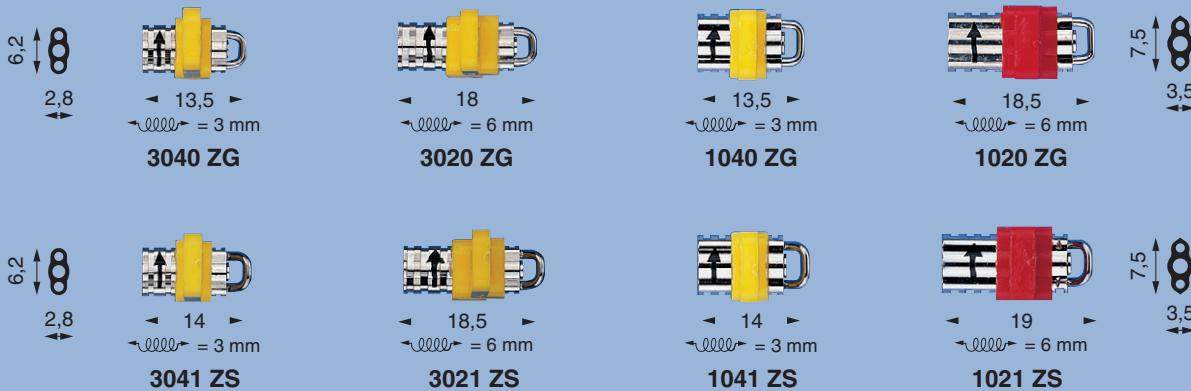

Richtung des U-Bügel bei allen Sektoren- und Zugschrauben:

U-bow direction of all sector and traction screws:

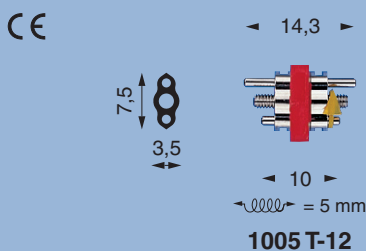
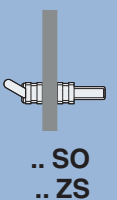
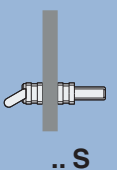
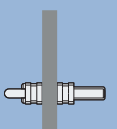

Trapezförmige Schrauben Für Engstände im Frontzahnbereich.

Trapezoidal screw
For narrow standing front tooth.

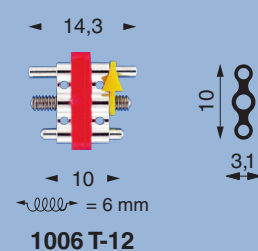



Standard-Serie

Stabile, skelettierte Dehnschrauben für den Oberkiefer mit Retentionsbohrungen. Gehäuse aus Neusilber, Führungsstifte und Gewindespindel aus Edelstahl.

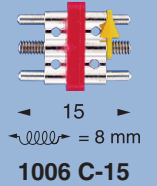
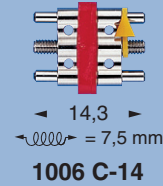
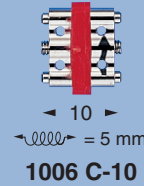
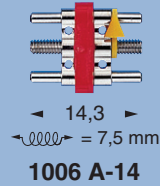
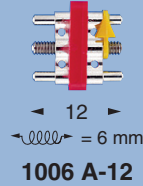
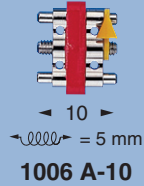

Standard Series

Stable expansion screws for the maxilla with retention drill holes. Nickel silver housing, guiding pins and thread spindle out of stainless steel.



Standard-Serie

Stabile, skelettierte Dehnschrauben für den Unterkiefer mit Retentionsbohrungen. Gehäuse aus Neusilber, Führungsstifte und Gewindespindel aus Edelstahl.

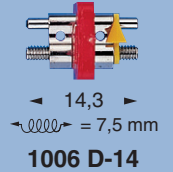
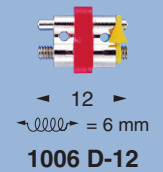
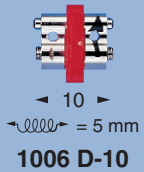
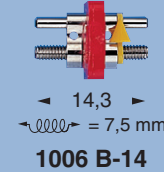
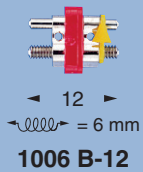
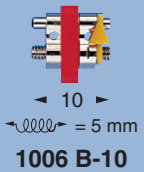

Standard Series

Stable expansion screws for the mandible with retention drill holes. Nickel silver housing, guiding pins and thread spindle out of stainless steel.



Bogenförmige Dehnschrauben

Für engstehende, schmale Oberkiefer. Gehäuse aus Neusilber. Führungsstifte und Gewindespindel aus Edelstahl.

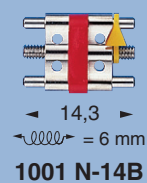
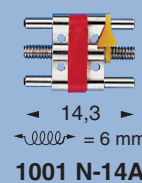
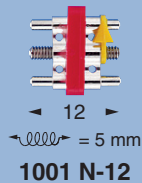
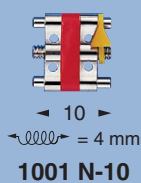

Arched Expansion Screws

For crowded, narrow maxillae. Nickel silver housing. Guiding pins and thread spindle out of stainless steel.

Exclusively by Lewa



Edelstahl-Dehnschrauben

Micro-Dehnschraube für Ober- u. Unterkiefer. Micro expansion screw for maxilla or mandible.

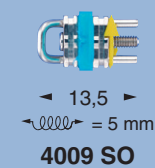
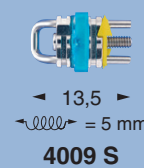
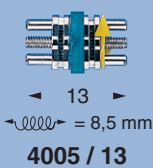
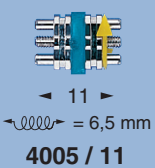
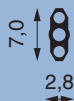

Stainless Steel Expansion Screws

Sektoren- und Zugschraube. Stabile U-Bügel-Retention gerade oder abgewinkelt. Skeleton-type sector- and traction screws. Stable U-bow retention, straight or bent.

Stabile Dehnschraube für den Oberkiefer. Mit Retentionsfräzung und großem Dehnbereich. Stable expansion screws for the maxilla. With retention groove and large expansion.

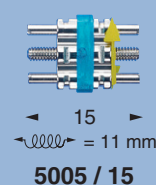
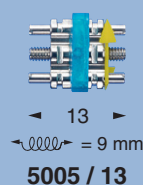
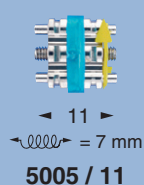

Vorschubdoppelplatte Bite-Jumping-Appliance

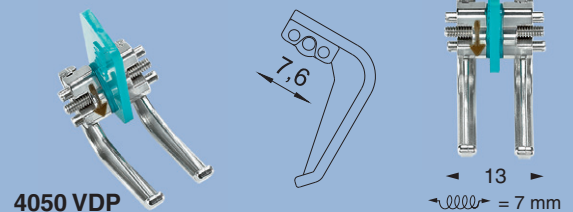

Dehnschrauben aus Kunststoff

Standard Dehnschrauben mit Gehäuse aus Spezialkunststoff reduzieren den Metallanteil im Mund und sind absolut rücklaufsicher. Führungsstifte und Spindel aus Edelstahl.

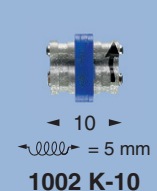
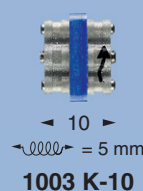
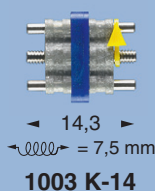

Plastic Expansion Screws

Standard expansion screws with special plastic housing reduce the content of metal in the mouth. Absolutely impossible to turn back. Guiding pins and thread spindle out of stainless steel.



Mehrsektorenschrauben nach Bertoni

Kombinierte Transversal- und Protrusionsschraube für 2 oder 3 unabhängig einstellbare Sektoren. Gerade oder abgewinkelte Ausführung. Mit Wachsabdichtungung.

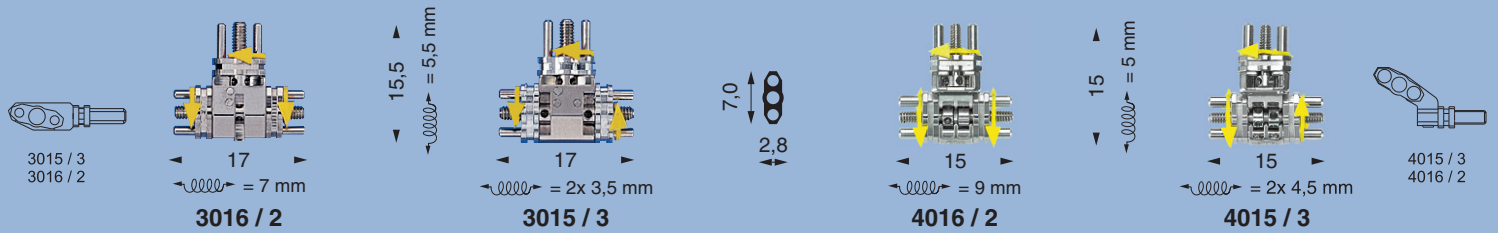

Multiple-Sectors Screws by Bertoni

Combined transversal and protrusion screw for 2 or 3 independently adjustable sectors. Straight or angled version. With wax space maintainer.



Spezial-Dehnschrauben

Unterkieferbogenschraube zur transversalen Erweiterung des UK-Frontbogens. Komplett aus Edelstahl.
Mandibular bow screw for transversal expansion of the mandibular anterior arch. Made of stainless steel.

Fächerdehnschrauben einteilig oder zweiteilig zur asymmetrischen Dehnung des Oberkiefers.
One- or two-piece fan-shaped expansion screws for asymmetric expansion of the maxilla.

Siemons-Dehnschraube für horizontal geteilte Aktivatoren.
Siemons expansion screws for horizontally separated activators.

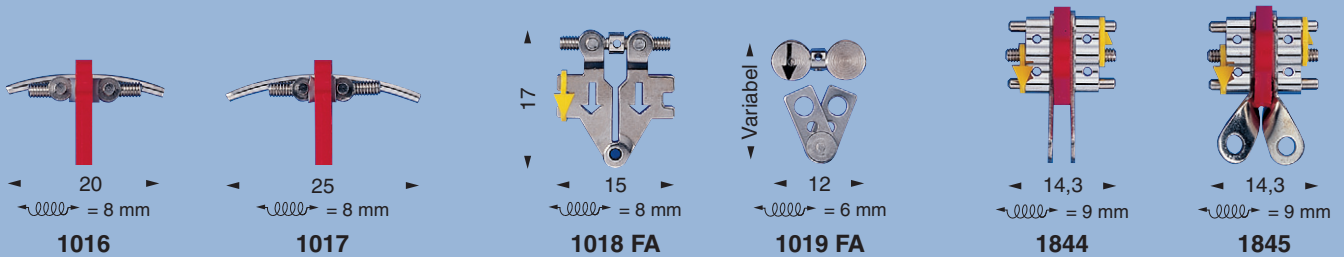

Edelstahl-Dehnschrauben

Besonders stabile Dehnschrauben für den universellen Gebrauch. Alle Modelle mit PA-Gewindesicherung und Platzhalter.

Stainless Steel Expansion Screws

Heavy-duty expansion screws for multiple applications. Each type with PA insertion nut and space maintainer.

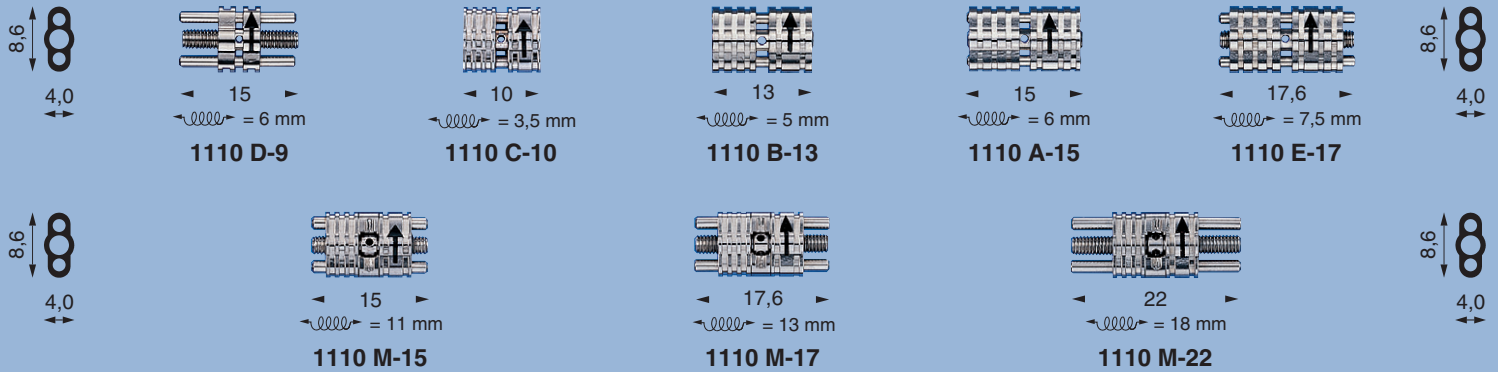

Federdehnschraube nach Prof. Hausser.
Spring-loaded expansion screw by Prof. Hausser.

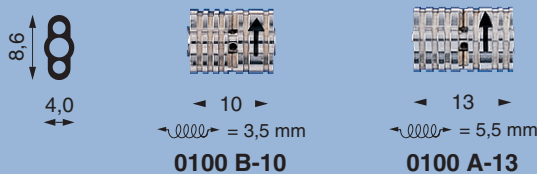

Einzelzahnbewegung

Federbolzenschrauben

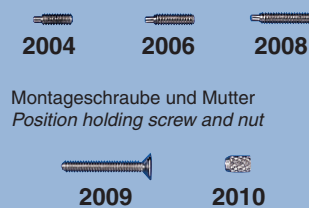

Single-Tooth Movements

Piston spring screws

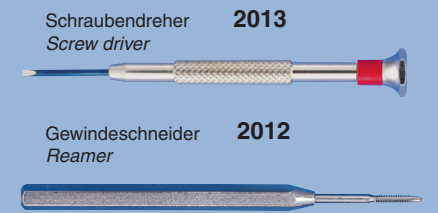

Teleskop-Dehnschrauben nach Planas

Telescopic Expansion Screws by Planas

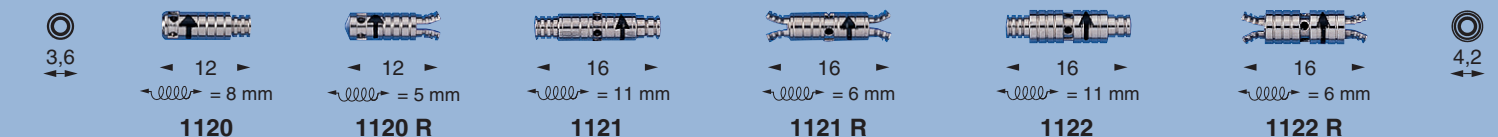

Gaumennaht-Schrauben

Retentionsarme lasergeschweißt, stabile Führungsstifte und Gewindespindel für größte Sicherheit und Kraftübertragung. M-Technik (nicht in 1114 / 10) garantiert maximale Biege- und Torsionsfestigkeit auch im gedehnten Zustand.

CE 0483

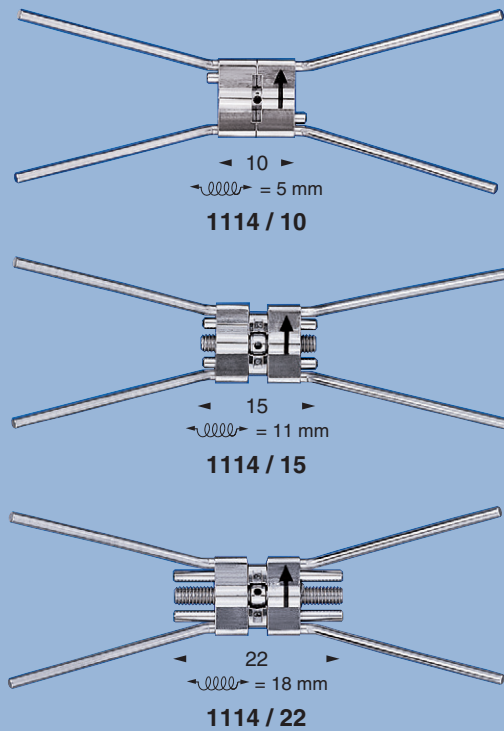

Palatal Suture Expansion Screws

Laser-welded retention arms. Stable guiding pins and thread spindle for utmost reliability and transmission of forces. M-technology (not in 1114 / 10) guarantees maximum bending and torsion strength when expanded.

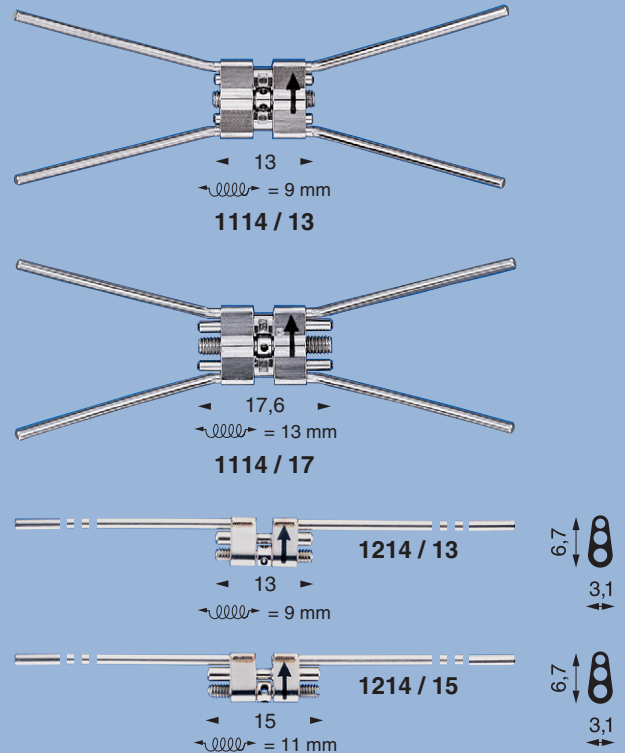

Dentaldrähte

Hochwertige Chrom-Nickel Dentaldrähte Ø 0,4 – Ø 1,2 mm. Festigkeitsstufen weich, hart und federhart. Weitere Informationen und Bestellnummern im separaten Infoprospekt oder unter www.lewa-dental.de

Dental Wires

High quality Chromium-Nickel dental wires, Ø 0,4 – Ø 1,2 mm (.016" - .048"). Quality soft, hard and spring hard. Further informations and article numbers in the separate brochure or at www.lewa-dental.de.

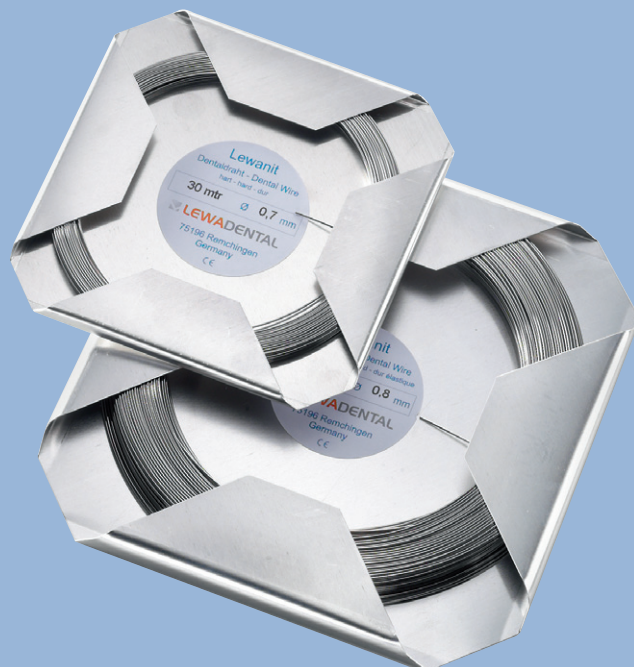

CE

Gesichtsbögen

Lasergeschweißt
4 verschiedene Außenbögen,
6 verschiedene Innenbögen,
mit oder ohne Stoppschlaufen.
Weitere Informationen und Bestellnummern im separaten Infoprospekt oder unter www.lewa-dental.de.

Facebows

Laser-welded
4 different labial arches,
6 different lingual arches,
with or without stopping loops.
Further informations and article numbers in the separate brochure or at www.lewa-dental.de.





Lewa-Dental

Feinmechanik GmbH & Co. KG
Darmsbacher Str. 3
D-75196 Remchingen

Phone ++49 (0)7232 72022
Fax ++49 (0)7232 79234
eMail info@lewa-dental.de
Web www.lewa-dental.de